

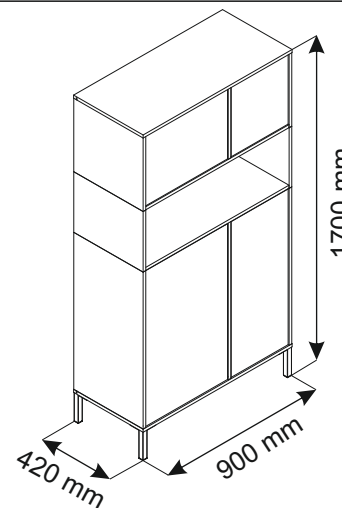

# Installation manual

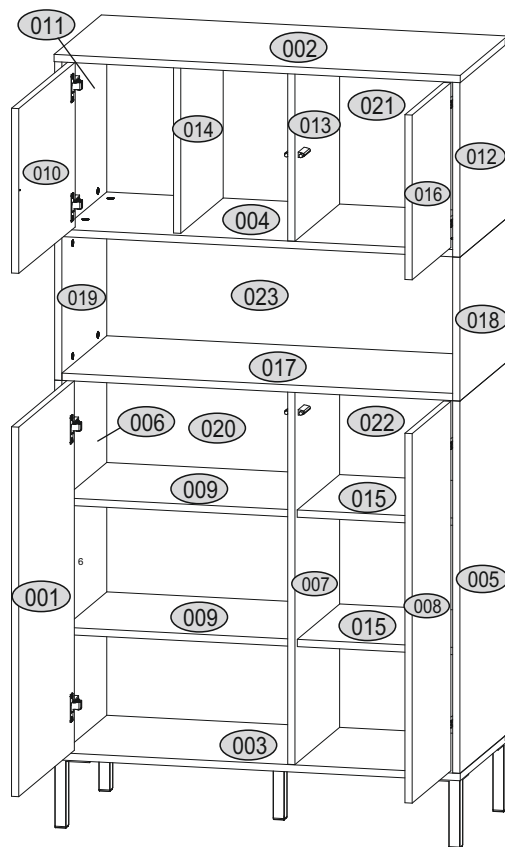

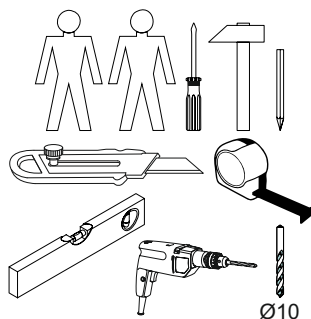

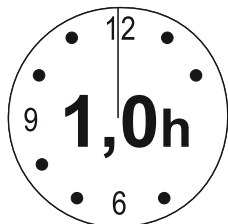

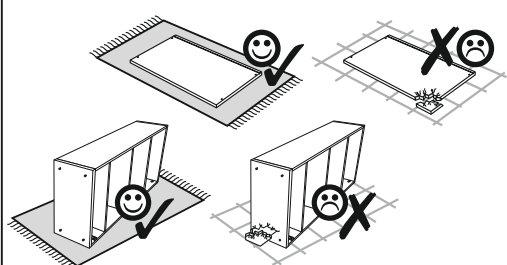
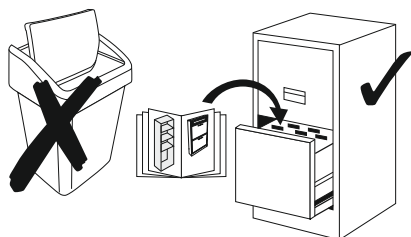







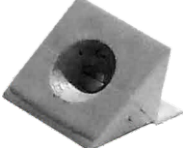

## Beril Shelving 4D



Code	Dimensions				Package
	812	494	16	1	
001	812	494	16	1	2/2
002	900	420	16	1	2/2
003	900	420	16	1	2/2
004	866	398	16	1	1/2
005	818	419	16	1	2/2
006	818	419	16	1	2/2
007	818	397	16	1	1/2
008	812	344	16	1	1/2
009	500	377	16	2	2/2
010	362	494	16	1	2/2
011	384	419	16	1	1/2
012	384	419	16	1	1/2
013	368	397	16	1	2/2
014	368	377	16	1	1/2
015	350	377	16	2	1/2
016	362	344	16	1	1/2
017	866	398	16	1	1/2
018	316	419	16	1	1/2
019	316	419	16	1	1/2
020	835	516	3	1	2/2
021	385	884	3	1	2/2
022	835	367	3	1	2/2
023	884	316	2,5	1	2/2
Accessories				1	1/2





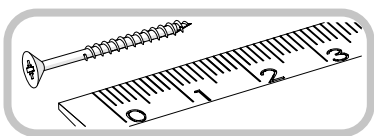

# Accessories:

<p>8x a311.60.919</p> 	<p>8x b218</p> 	<p>6x e1 Ø7x50</p> 	<p>36x f1 Ø8x30</p> 
<p>1x f3</p> 	<p>12x l2</p> 	<p>5x k311.054</p> 	<p>4x m30.1</p> 
<p>1x n14</p> 	<p>8x n260.01</p> 	<p>1x p17 Ø6x50</p> 	<p>66x p25 Ø3.5x16</p> 
<p>38x r1 15x12</p> 	<p>8x r10 Ø7x34</p> 	<p>22x r16 Ø7x24</p> 	<p>38x s2</p> 
<p>16x d1 Ø5x16</p> 	<p>1x z1</p> 		



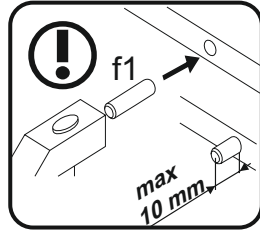
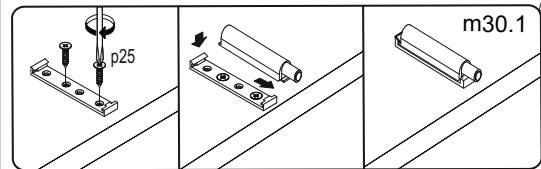
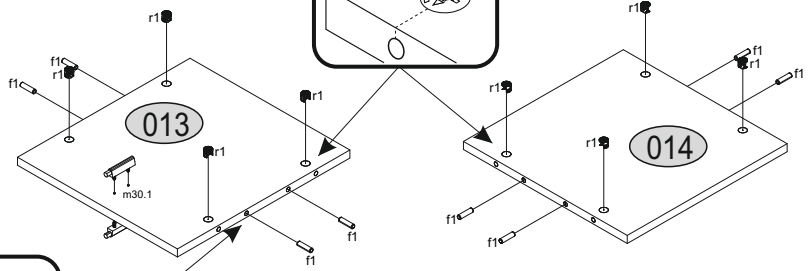
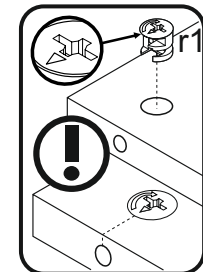
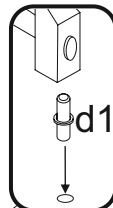
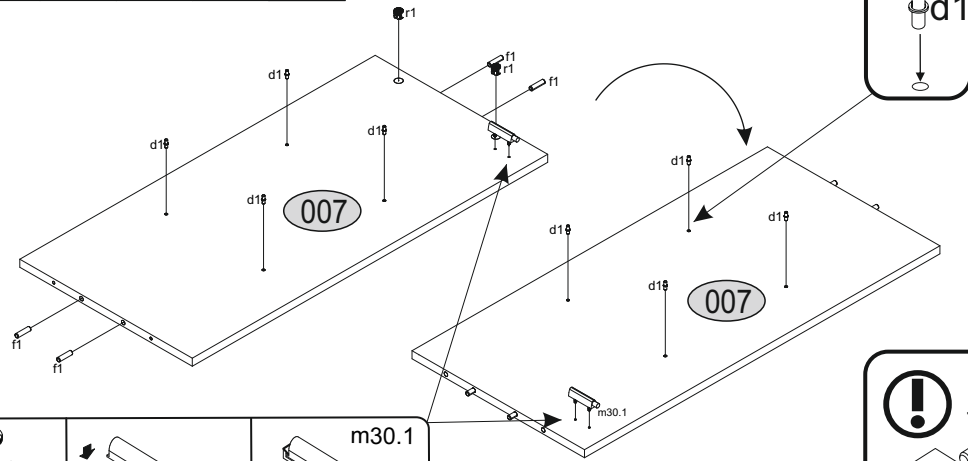

# 1

<b>f1</b> 	<b>r1</b> 	<b>d1</b> 	<b>m30.1</b> 	<b>p25</b> 
x12	x10	x8	x4	x8



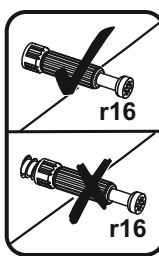
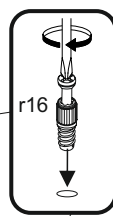
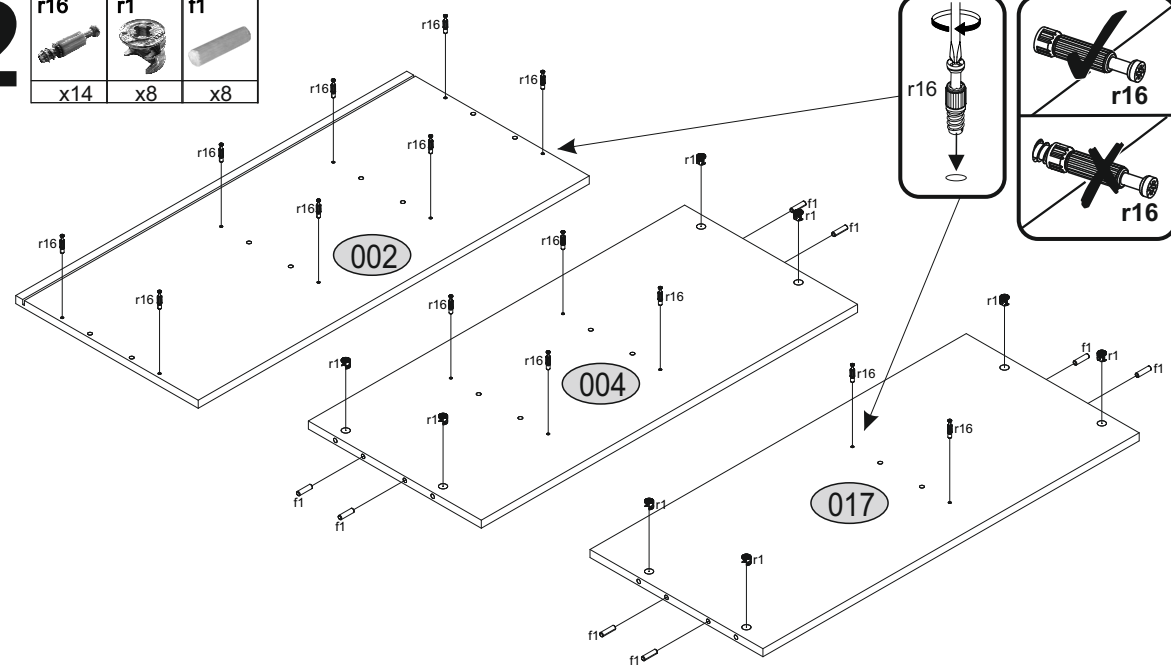

# 2

<b>r16</b> 	<b>r1</b> 	<b>f1</b> 
x14	x8	x8



# 3

<b>r16</b> 	<b>r1</b> 
x4	x8

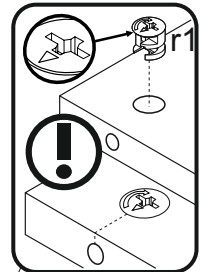
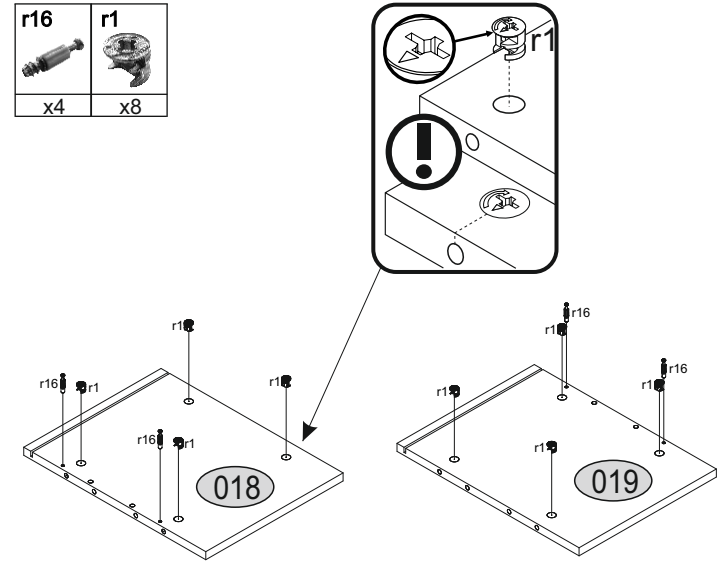

# 4

<b>f1</b> 	<b>r1</b> 	<b>d1</b> 	<b>b218</b> 	<b>r16</b> 
x16	x12	x8	x8	x4

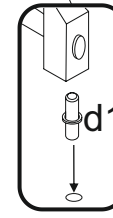
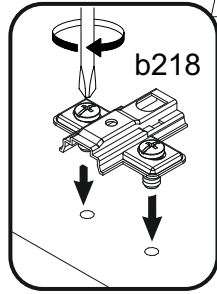
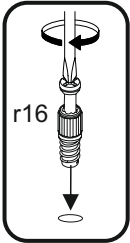
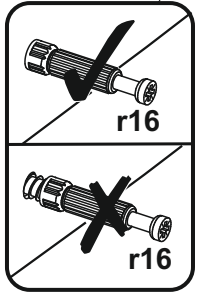
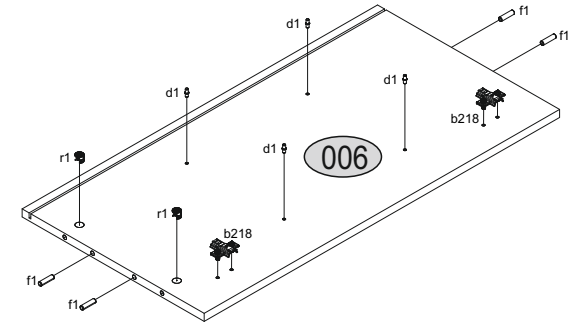
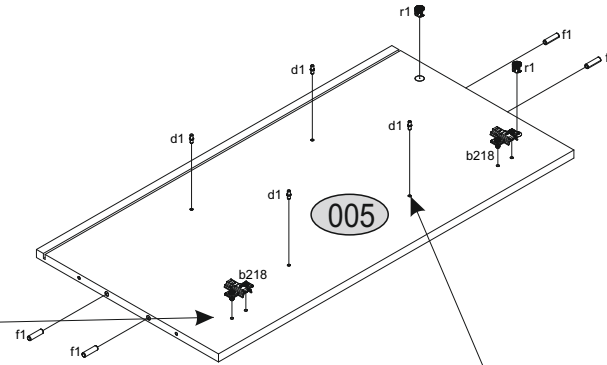
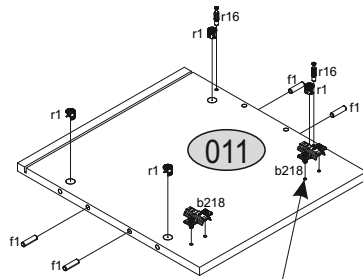
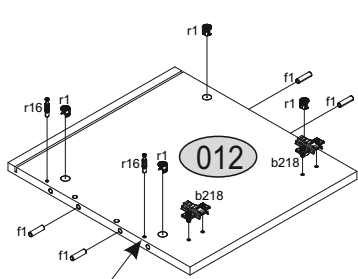

# 5

<b>p25</b> 	<b>a311.60.919</b> 	<b>m30.1</b> 
x16	x8	x4

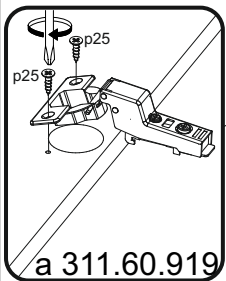
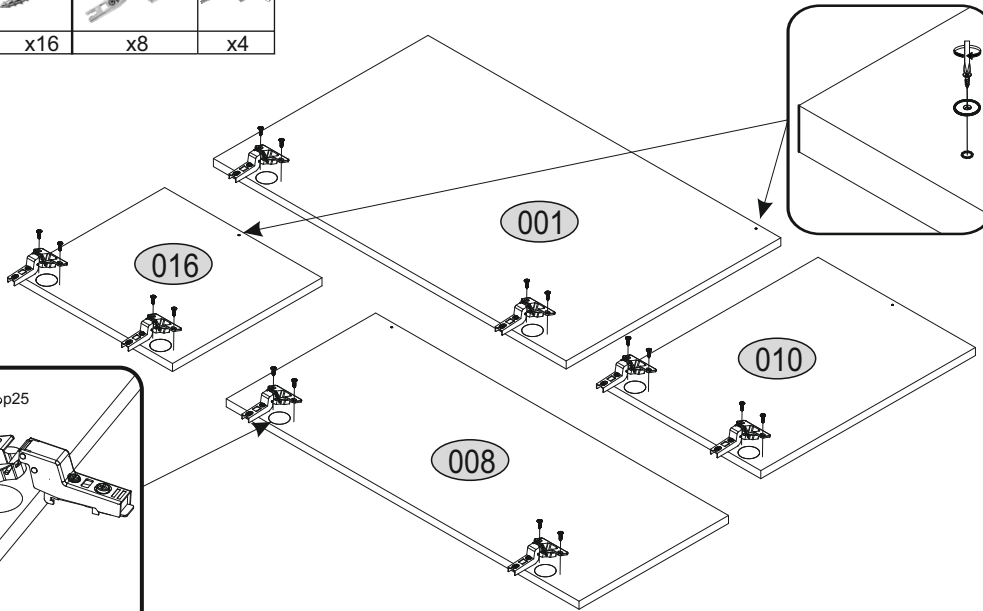

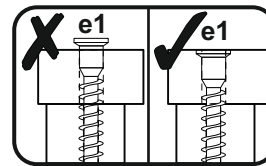
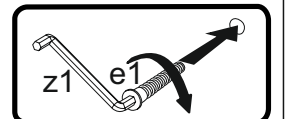
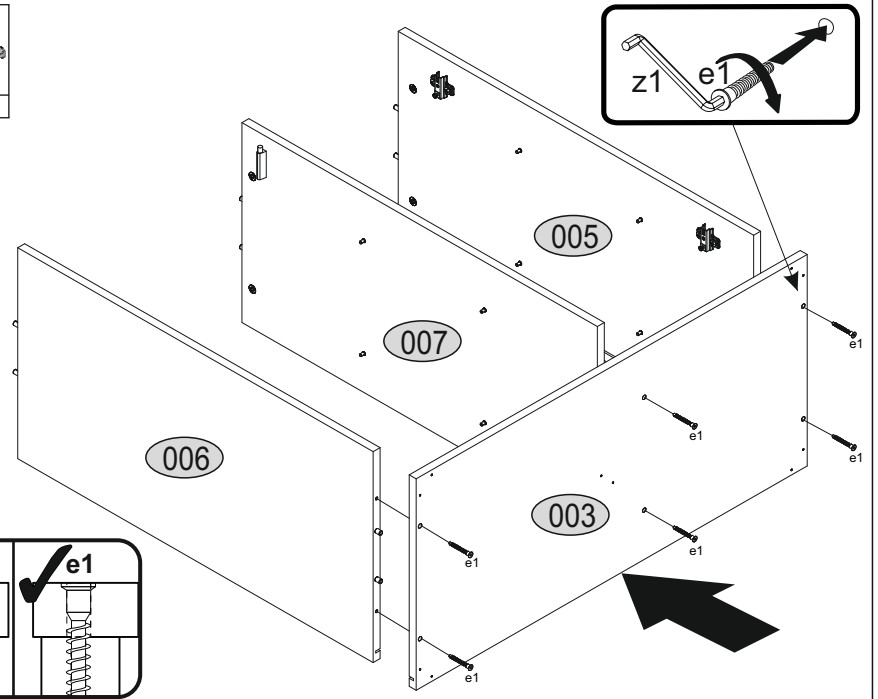

# 6

<b>e1</b> 
x6



# 7

p25 	k311.054 
x20	x5

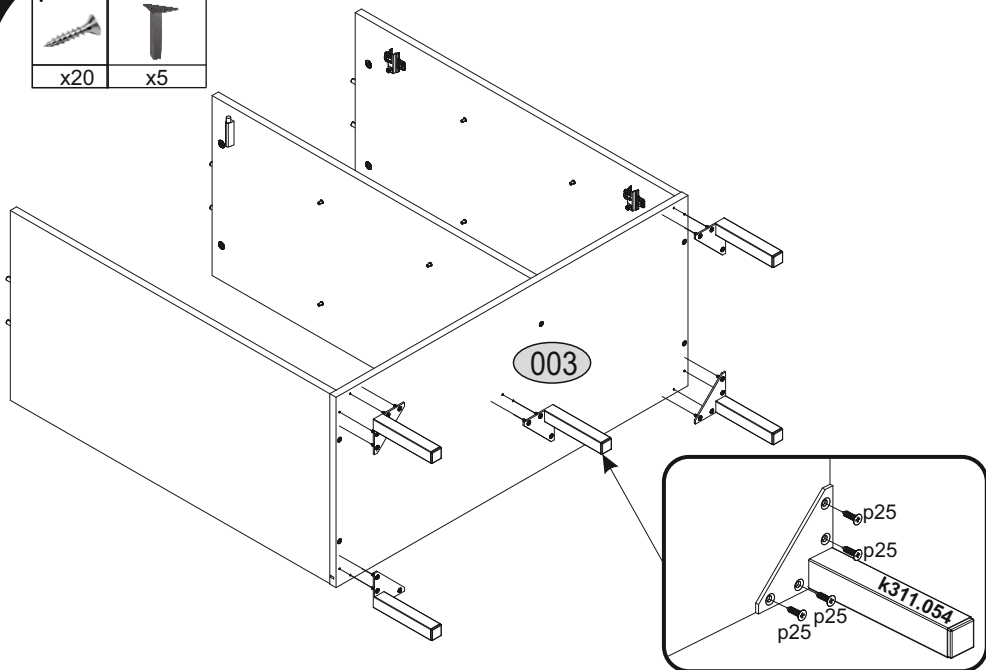

# 8

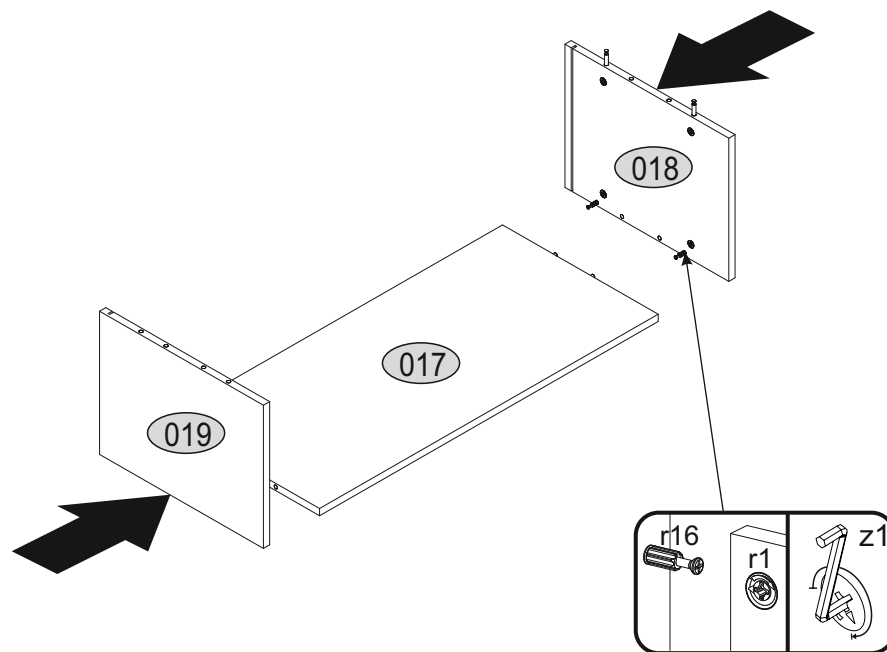

# 9

r10 
x4

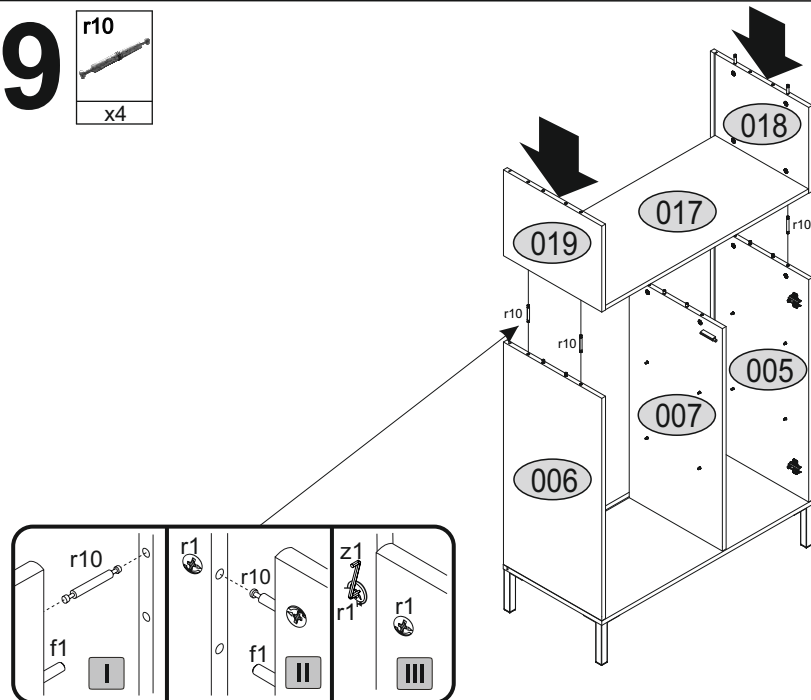

# 10

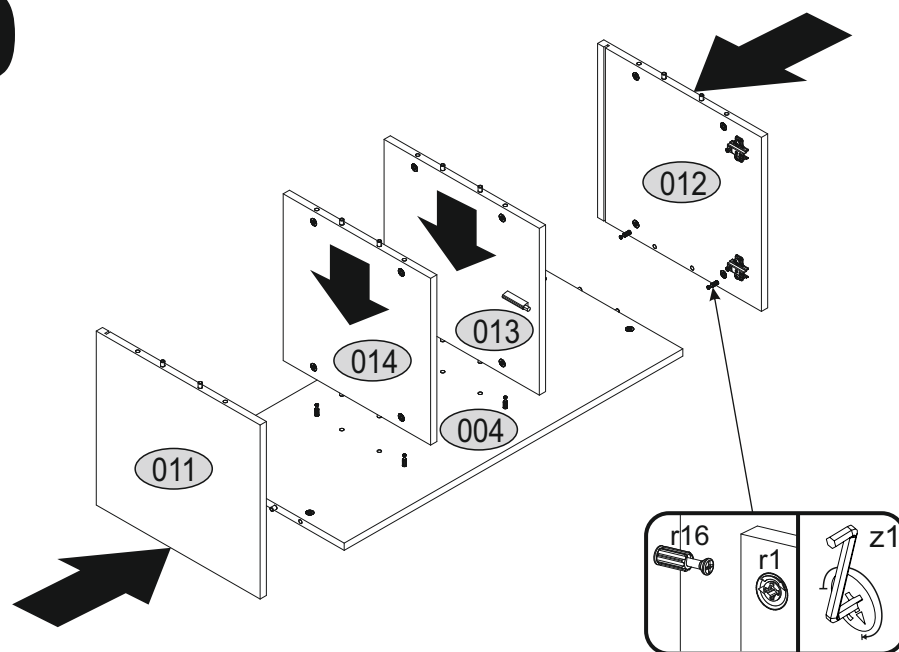

# 11

r10
x4

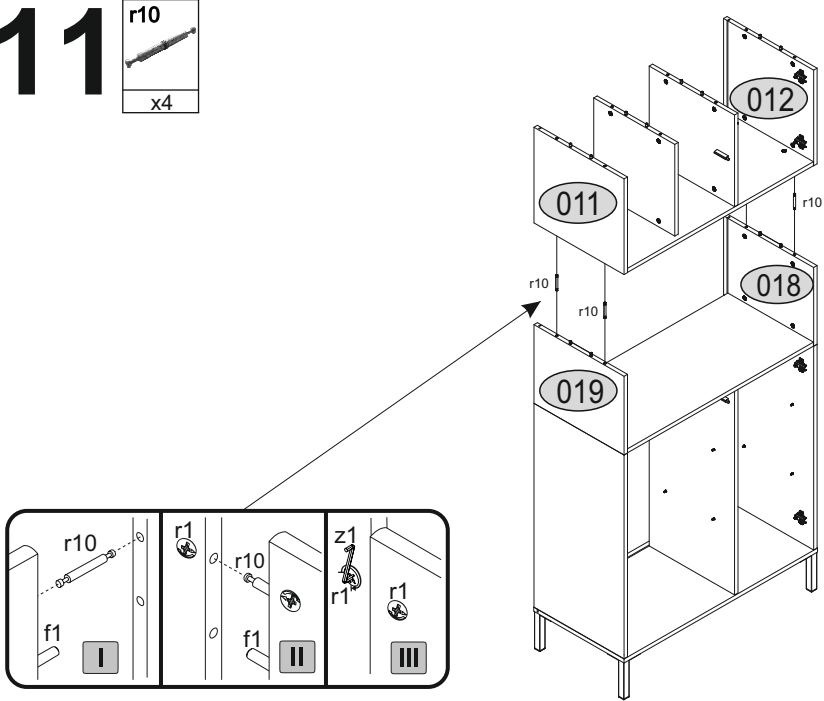

# 12

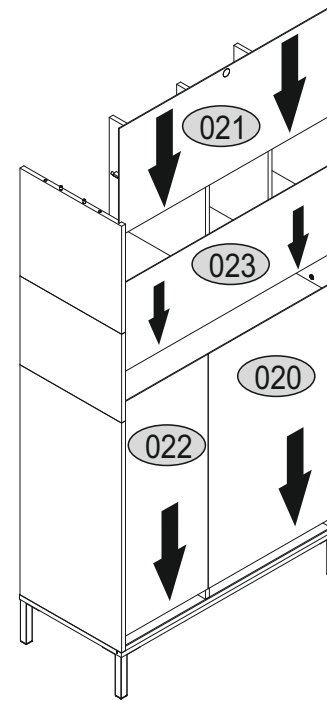

# 13

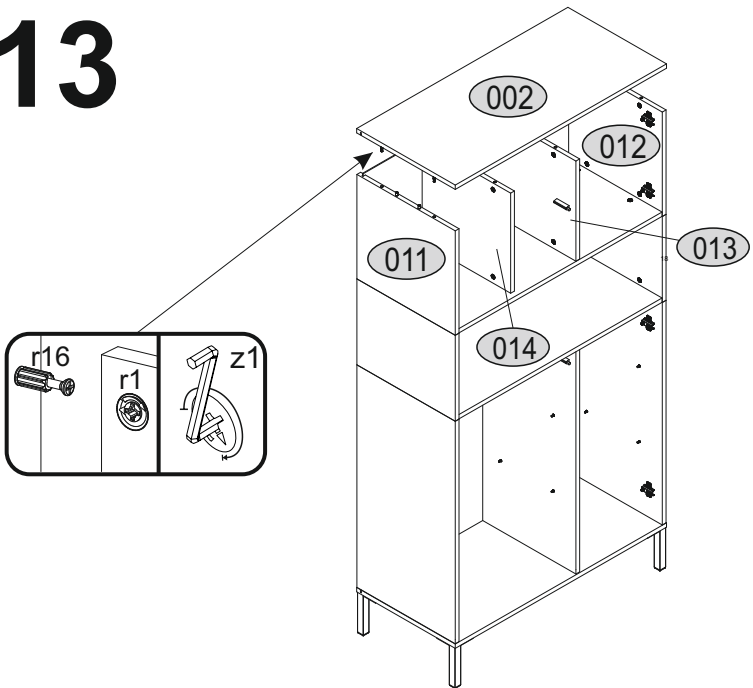

# 14

p17	p25	n14	n260.01	l2	f3
x1	x22	x1	x8	x12	x1

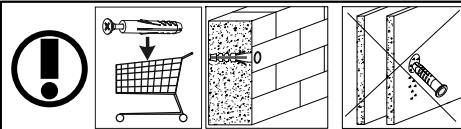
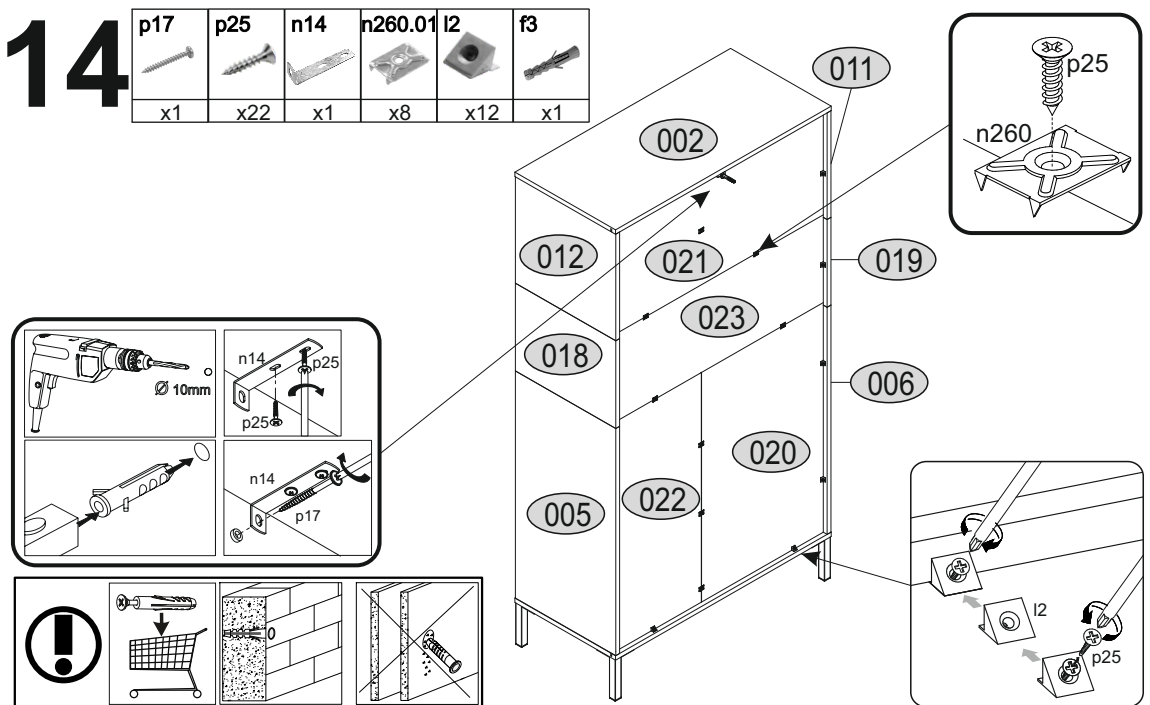

# 15

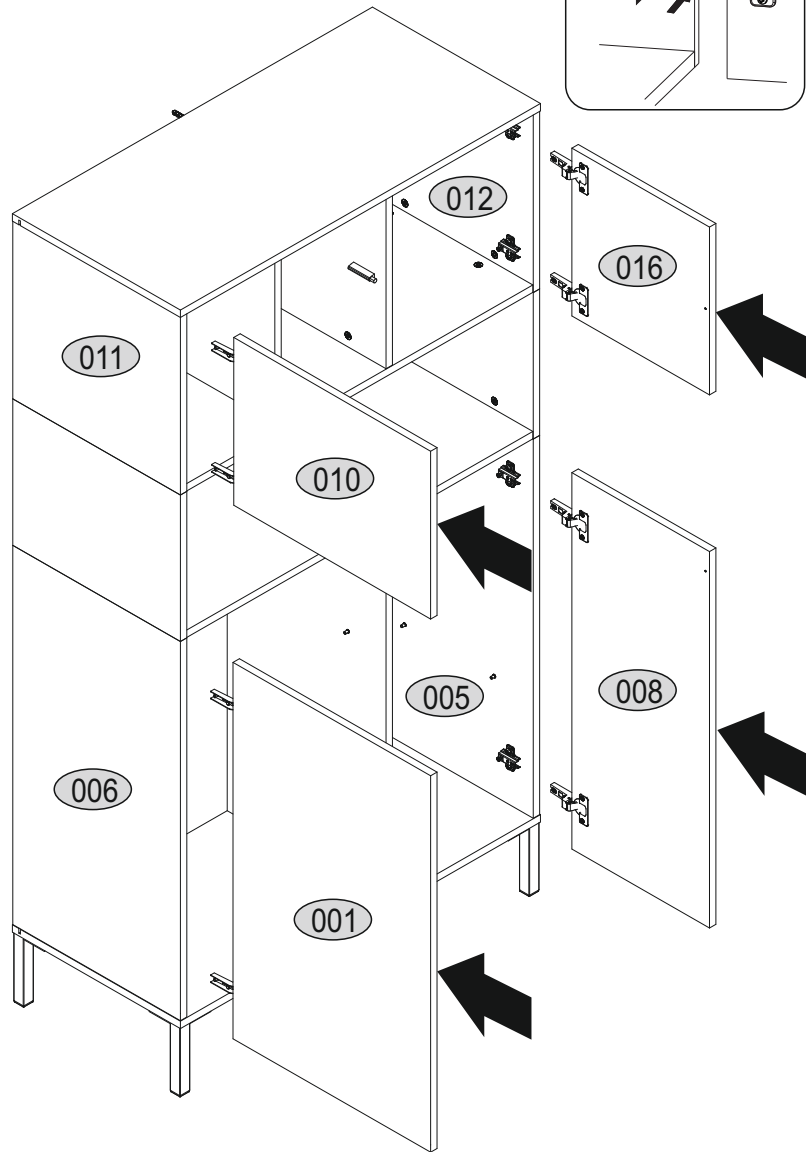
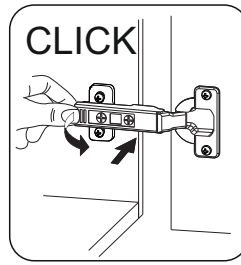

# 16

